

Please write clearly in block capitals.

Centre number

--	--	--	--	--

Candidate number

--	--	--	--

Surname

Forename(s)

Candidate signature

GCSE PHYSICS

H

Higher Tier Unit Physics P3

Friday 17 June 2016

Morning

Time allowed: 1 hour

Materials

For this paper you must have:

- a ruler
- a calculator
- the Physics Equations Sheet (enclosed).

Instructions

- Use black ink or black ball-point pen.
- Fill in the boxes at the top of this page.
- Answer **all** questions.
- You must answer the questions in the spaces provided. Do not write outside the box around each page or on blank pages.
- Do all rough work in this book. Cross through any work you do not want to be marked.

Information

- The marks for questions are shown in brackets.
- The maximum mark for this paper is 60.
- You are expected to use a calculator where appropriate.
- You are reminded of the need for good English and clear presentation in your answers.
- Question 1(b) should be answered in continuous prose.
In this question you will be marked on your ability to:
 - use good English
 - organise information clearly
 - use specialist vocabulary where appropriate.

Advice

- In all calculations, show clearly how you work out your answer.



Answer **all** questions in the spaces provided.

- 1 (a)** Electromagnets are often used at recycling centres to separate some types of metals from other materials.

Give **one** reason why an electromagnet would be used rather than a permanent magnet.

[1 mark]

- 1 (b)** In this question you will gain marks for using good English, organising information clearly and using scientific words correctly.

Some students want to build an electromagnet.

The students have the equipment shown in **Figure 1**.

Figure 1

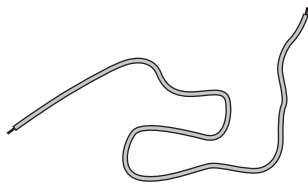

Insulated wire



Iron nail

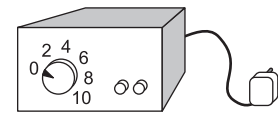

Power supply

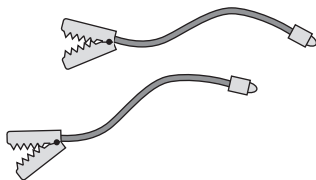

Connecting leads

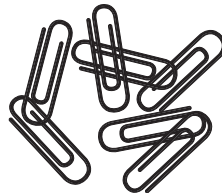

Steel paperclips

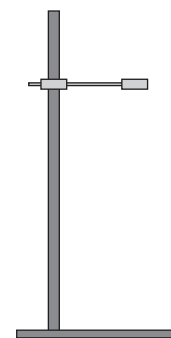

Wooden clamp
and stand



Describe how the students could build an electromagnet. Include in your answer how the students should vary and test the strength of their electromagnet.

[6 marks]

Extra space

7

Turn over ►



There are no questions printed on this page

**DO NOT WRITE ON THIS PAGE
ANSWER IN THE SPACES PROVIDED**



2 **Figure 2** shows the structure of a traditional transformer.

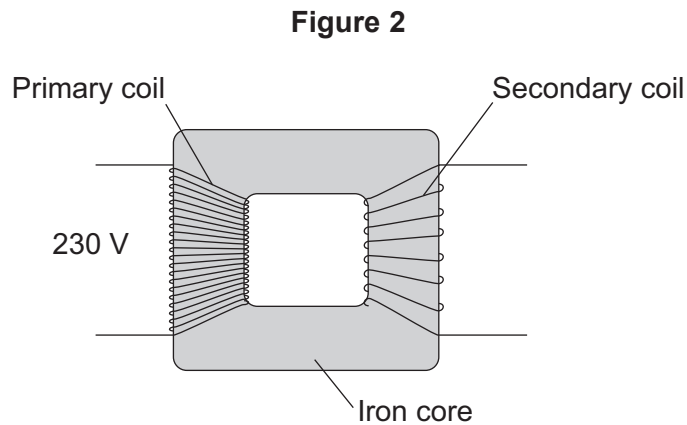

2 (a) There is an alternating current in the primary coil of the transformer.

State what is produced in the iron core.

[2 marks]

2 (b) A transformer has only **one** turn of wire on the secondary coil.
The potential difference across the secondary coil is 11.5 V
The potential difference across the primary coil is 230 V

Calculate the number of turns on the primary coil.

Use the correct equation from the Physics Equations Sheet.

[2 marks]

Number of turns on the primary coil = _____

Question 2 continues on the next page

Turn over ►



2 (c) In most transformers, the power output is less than the power input.

State why.

[1 mark]

2 (d) Two students investigated how magnets can be used to produce a potential difference. The students held a coil of wire above a magnet. The students quickly lowered the coil so that the magnet was inside the coil, as shown in **Figure 3**.

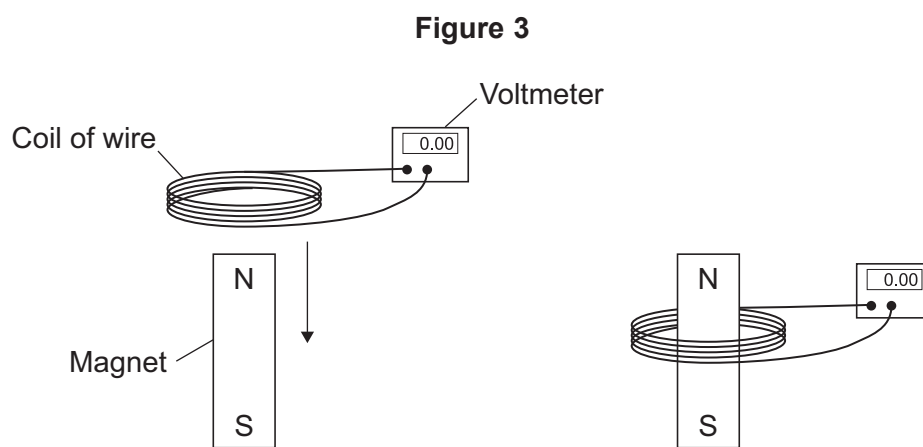

The students recorded the maximum potential difference for coils with different numbers of turns of wire. The results are shown in **Table 1**.

Table 1

Number of turns of wire in the coil	Maximum potential difference in volts	
	Results from student 1	Results from student 2
5	0.09	0.08
10	0.20	0.15
15	0.31	0.25
20	0.39	0.33
25	0.51	0.39



2 (d) (i) State the resolution of the voltmeter.

Give **one** reason why the resolution of the voltmeter is suitable for this investigation.

[2 marks]

Resolution _____

Reason _____

2 (d) (ii) The two students used exactly the same equipment to carry out their investigations. Both students recorded their results correctly.

Give the reason why student 2 got different results from student 1.

[1 mark]

2 (d) (iii) The students decided that even though the results were different, there was no need to repeat the investigation.

How do the results show that the investigation is reproducible?

[1 mark]

2 (d) (iv) State the name of the process which causes the potential difference to be produced in this investigation.

[1 mark]

2 (e) A transformer has been developed that can be used with many different devices.

Suggest **one** advantage of having a transformer that can be used with many different devices.

[1 mark]



3 X-rays and ultrasound can both be used for scanning internal organs.

3 (a) Ultrasound is used to scan unborn babies but X-rays are **not** used to scan unborn babies.

Explain why.

[3 marks]

3 (b) The behaviour of ultrasound waves when they meet a boundary between two different materials is used to produce an image.

Describe how.

[2 marks]



- 3 (c) **Figure 4** shows two pulses from a scan of an unborn baby. The emitted pulse is labelled **A**. The returning pulse picked up by the receiver is labelled **B**.

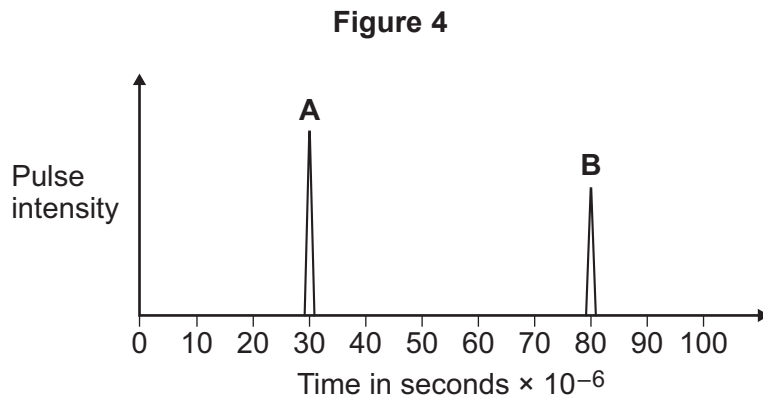

The closest distance between the unborn baby and the mother's skin is 4.0 cm. Use information from **Figure 4** to calculate the average speed of the pulse.

Use the correct equation from the Physics Equations Sheet.

[3 marks]

Average speed = _____ m/s

Question 3 continues on the next page

Turn over ►



3 (d) Figure 5 shows an X-ray of an arm with a broken bone.

Figure 5



3 (d) (i) Describe how X-rays are able to produce an image of bones.

[3 marks]

3 (d) (ii) Complete the following sentence.

X-rays are able to produce detailed images because their wavelength

is very _____ .

[1 mark]

12



Turn over for the next question

**DO NOT WRITE ON THIS PAGE
ANSWER IN THE SPACES PROVIDED**

Turn over ►



4 **Figure 6** shows a ray of light going from air into an optical fibre and then travelling through part of the optical fibre.

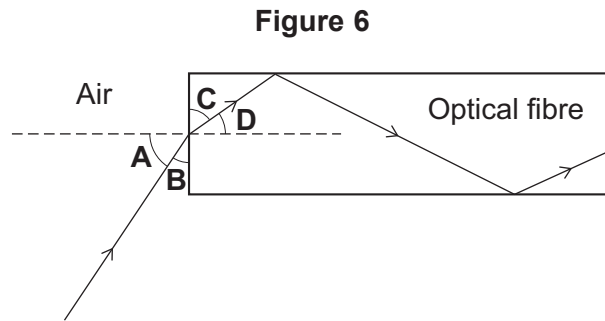

4 (a) Which **one** of the following pairs of angles correctly identifies the angle of incidence and the angle of refraction?

[1 mark]

Tick (✓) **one** box.

Angle of incidence	Angle of refraction	Tick (✓)
A	C	
A	D	
B	C	
B	D	

4 (b) The glass used to make this optical fibre has a refractive index of 1.5.

Calculate the critical angle of the glass.
Give your answer to 2 significant figures.

Use the correct equation from the Physics Equations Sheet.

[3 marks]

Critical angle = _____ degrees



4 (c) Short pulses of light can carry information through optical fibres.

Each pulse is made of lots of light rays. The light rays refract into the optical fibres at different angles when the pulse is sent.

The paths of two possible rays, **A** and **B**, are shown in **Figure 7**. These rays make up part of the pulse shown in **Figure 8**.

Figure 7

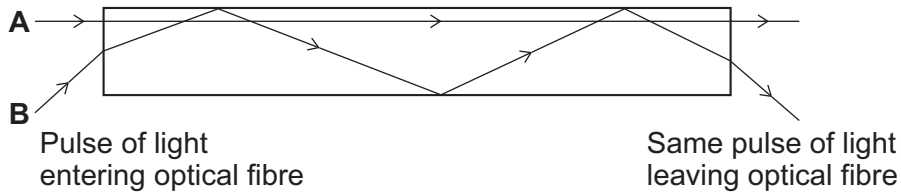

A pulse of light entering the optical fibre has changed when it leaves the optical fibre, as shown in **Figure 8**.

Figure 8

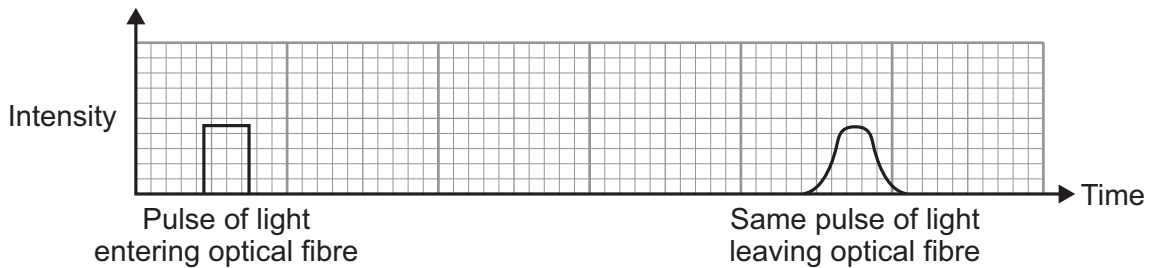

By considering the paths of rays **A** and **B**, explain why the pulse of light shown in **Figure 8** changed as it passed through the optical fibre.

[2 marks]

6

Turn over ►



- 5 A drum is hit by a beater attached to a drumstick lever. The drumstick lever is attached to a foot-pedal by a chain, as shown in **Figure 9**.

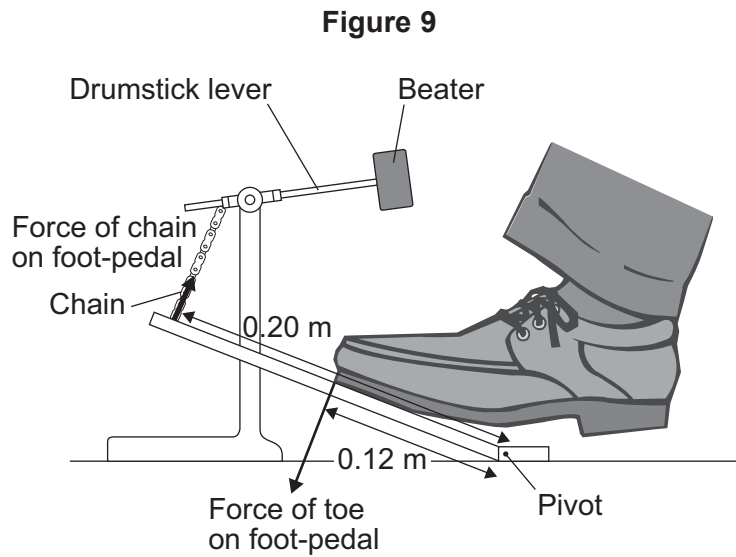

- 5 (a) When the toe is pushed down the force creates a moment on the foot-pedal.
- 5 (a) (i) State what is meant by the moment of a force.

[1 mark]

- 5 (a) (ii) The foot-pedal is pushed halfway down and held stationary. The toe and the chain both exert a force on the foot-pedal.

Compare the sizes and directions of the moments caused by the force of the toe and the force of the chain on the foot-pedal.

[1 mark]



- 5 (a) (iii)** The drummer's toe pushes with a 1.5 N force on the foot-pedal.
The perpendicular distance from the pivot to the force is 0.12 m.
The perpendicular distance from the pivot to the chain is 0.20 m.

Calculate the force of the chain acting on the foot-pedal.

Use the correct equation from the Physics Equations Sheet.

[3 marks]

Force = _____ N

Question 5 continues on the next page

Turn over ►



5 (b) The foot-pedal is pushed with different forces to make the beater move at different speeds.

The higher the speed at which the beater hits the drum, the louder the sound the drum makes.

Figure 10 shows how the length of the drumstick lever affects the speed of the beater for three different forces.

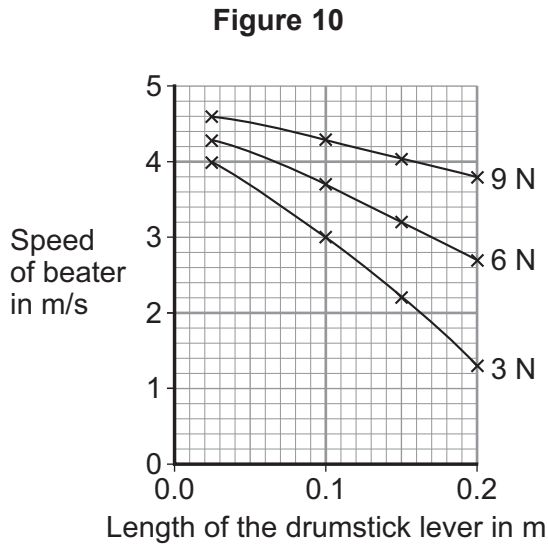

The drummer needs to be able to sometimes play the drum quietly and sometimes loudly.

How does the **length** of the drumstick lever affect the variation in loudness of the sound from the drum when applying:

[2 marks]

a force of 3 N? _____

a range of forces from 3 N to 9 N? _____

7



Turn over for the next question

**DO NOT WRITE ON THIS PAGE
ANSWER IN THE SPACES PROVIDED**

Turn over ►



- 6 In a balancing game, wooden blocks are used to build a tower. The shape of the tower at the start of the game is shown in **Figure 11**. During the game, some of the blocks are taken out and put on top of the tower as shown in **Figure 12**. This causes the centre of mass of the tower to change.

Figure 11

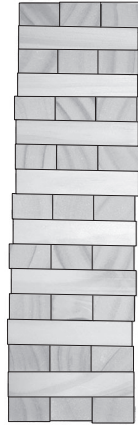
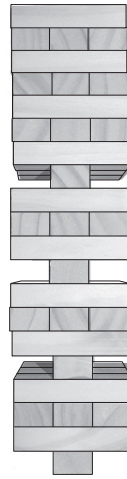

Figure 12



- 6 (a) (i) State what is meant by the term 'centre of mass'.

[1 mark]

- 6 (a) (ii) Give **two** reasons why the tower in **Figure 12** is less stable than the tower in **Figure 11**.

[2 marks]

1

2



6 (b) Figure 13 shows a different arrangement for the wooden blocks.

Figure 13



A block was placed in position **A** and an identical block was placed in position **B** at the same time.

Explain why the tower did not fall over. You should include reference to moments in your answer.

[2 marks]

5

Turn over for the next question

Turn over ►



7 (a) Some people have an eye defect called long sight.

7 (a) (i) State **one** cause of long sight.

[1 mark]

7 (a) (ii) Long sight can be corrected by surgery. During surgery, the surgeon may need to cut and heat very delicate parts of the eye.

Name the piece of equipment which provides the energy source used to do this.

[1 mark]

7 (b) A light bulb is placed between a convex lens and the principle focus of this lens, at position **N** shown in **Figure 14**. The light bulb is then moved to position **M**, a large distance from the lens.

Figure 14

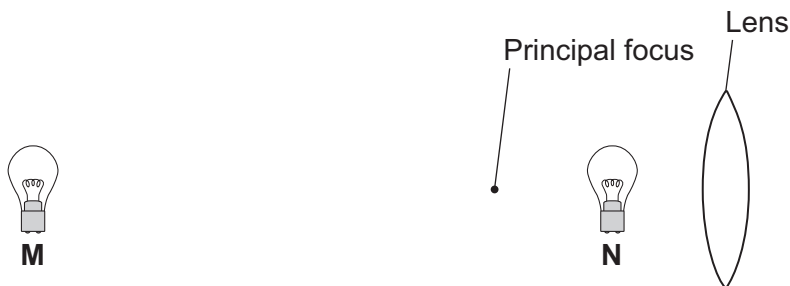

Describe how the nature of the image formed changes as the light bulb is moved from position **N** to position **M**.

[3 marks]



7 (c) An object, **O**, is very near to a convex lens, as shown in **Figure 15**.

Complete **Figure 15** to show how rays of light from the object form an image.

[3 marks]

Figure 15

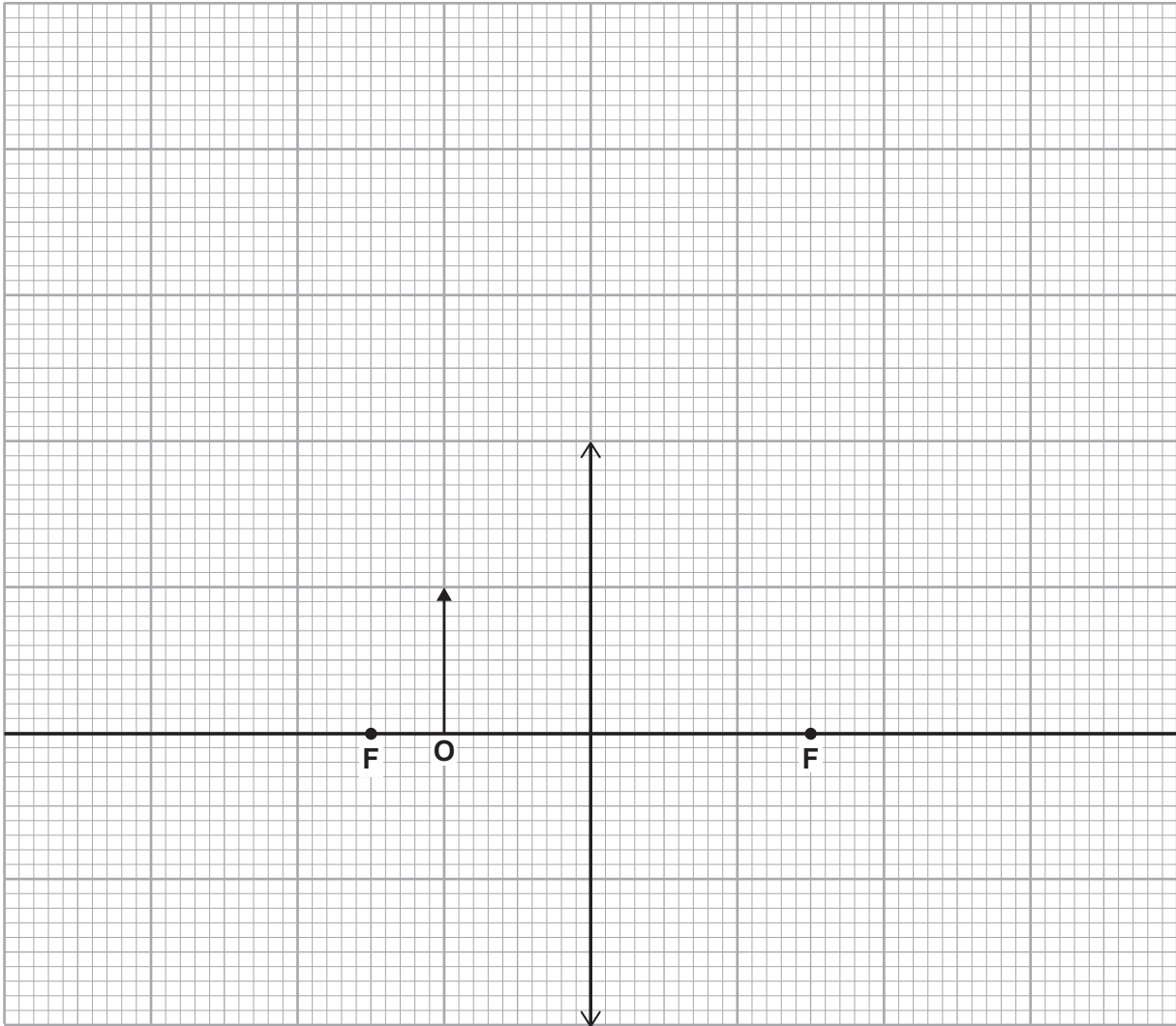

Question 7 continues on the next page

Turn over ►



- 7 (d) The object distance is the distance from an object to the lens. The image distance is the distance from the lens to the image.

Figure 16 shows how the image distance changes with the object distance, for two identically shaped convex lenses, **A** and **B**. Each lens is made from a different type of glass.

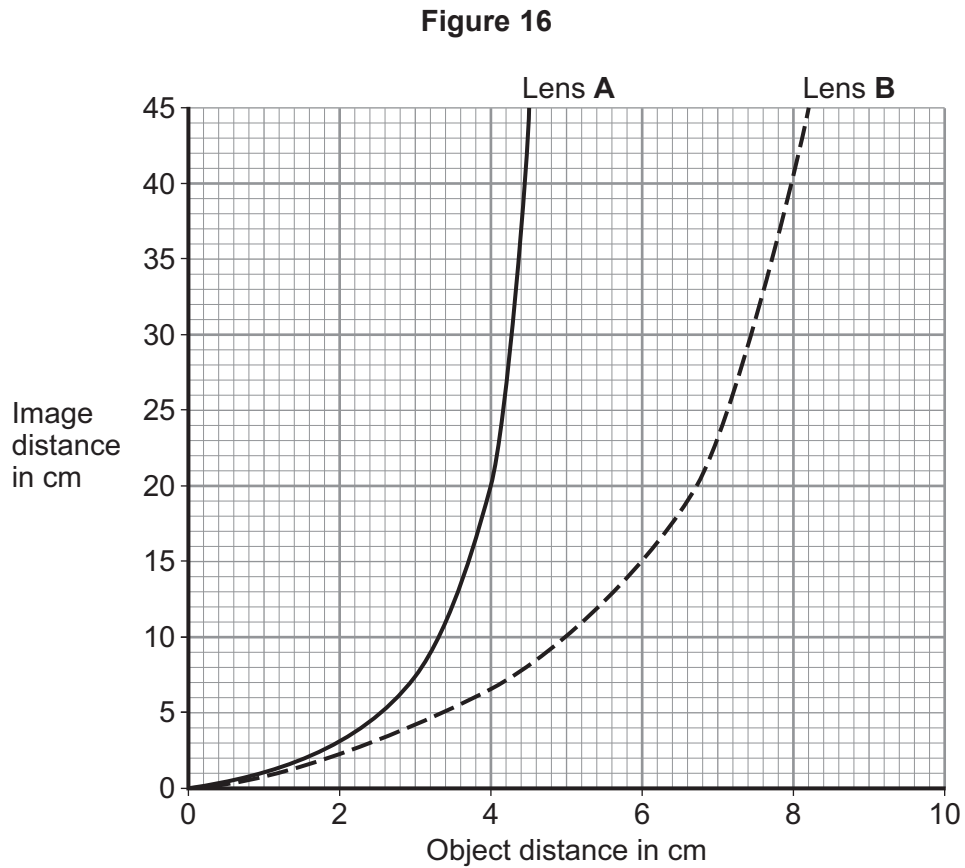

- 7 (d) (i) When the object distance is 4 cm, the image distance for lens **A** is longer than for lens **B**.

State why.

[1 mark]



- 7 (d) (ii) When the object is moved between lens **B** and the principal focus, the image size changes. **Table 2** shows the magnification produced by lens **B** for different object distances.

Table 2

Object distance in cm	Magnification
0.0	1
5.0	2
6.7	3
7.5	4
8.0	5

Using information from **Figure 16** and **Table 2**, describe the relationship between the **image** distance and the magnification produced by lens **B**.

[2 marks]

- 7 (d) (iii) A third convex lens, lens **C**, is made from the same type of glass as lens **B**, but has a shorter focal length than lens **B**.

Lens **B** is shown in **Figure 17**.

Complete **Figure 17** to show how lens **C** is different from lens **B**.

[1 mark]

Figure 17



Lens **B**

Lens **C**

12

END OF QUESTIONS



There are no questions printed on this page

**DO NOT WRITE ON THIS PAGE
ANSWER IN THE SPACES PROVIDED**

Copyright information

For confidentiality purposes, from the November 2015 examination series, acknowledgements of third party copyright material will be published in a separate booklet rather than including them on the examination paper or support materials. This booklet is published after each examination series and is available for free download from www.aqa.org.uk after the live examination series.

Permission to reproduce all copyright material has been applied for. In some cases, efforts to contact copyright-holders may have been unsuccessful and AQA will be happy to rectify any omissions of acknowledgements. If you have any queries please contact the Copyright Team, AQA, Stag Hill House, Guildford, GU2 7XJ.

Copyright © 2016 AQA and its licensors. All rights reserved.

